

Logarithmic Hybrid Amplifiers

RTI has developed a series of hybrid log amplifiers that are small in size, light in weight, and high on reliability. These units provide a detected video output voltage logarithmically proportional to the input IF power. Specifically designed for use in electronic warfare and radar receiving systems, these units deliver fast rise and fall time pulse characteristics.



General Specifications

Linearity	± 1 dB (add ± 0.5 dB over Temperature) (-30°C to $+71^{\circ}\text{C}$)
Sensitivity	25mV/dB (typ)
Source Impedance	50 Ohms
Video Load Impedance	93 Ohms
Power Requirements	± 15 VDC
Connectors	SMA

Key Features

- 80dB Dynamic Range
- ± 1 dB Linearity
(add ± 0.5 dB over Temperature)
- DC Coupled Video
- Built-in Voltage Regulation
- Excellent Pulse Response

Optional Specifications

Limited IF Output	0 dBm (add suffix B) or 10 dBm (add suffix B+)
Power Supplies	± 12 VDC (add suffix C)
Matched Set	2, 3 units/set (add suffix M)

Design Note: Radar Technology can customize any of our products to meet your individual system requirements. RTI also offers many form, fit, function replacements to old RHG Electronics Amplifiers.

Specification Table

Model	Center Frequency (MHz)	Bandwidth (MHz)	Rise Time (μs)	Dynamic Range (dB)	Input Power (dBm)
RTL-4-1003	10	3	0.5	80	-80 to 0
RTL-4-3002	30	2	0.5	80	-80 to 0
RTL-4-3004	30	4	0.25	80	-80 to 0
RTL-4-3010	30	10	0.1	80	-80 to 0
RTL-4-4510	45	10	0.1	80	-80 to 0
RTL-4-6010	60	10	0.1	80	-80 to 0
RTL-4-6020	60	20	0.05	80	-80 to 0
RTL-4-7010	70	10	0.1	80	-80 to 0
RTL-4-7020	70	20	0.05	80	-80 to 0
RTL-4-12020	120	20	0.05	70	-70 to 0
RTL-4-12040	120	40	0.03	70	-70 to 0
RTL-4-16020	160	20	0.05	70	-70 to 0
RTL-4-16030	160	30	0.04	70	-70 to 0
RTL-4-16040	160	40	0.03	70	-70 to 0

Outline Drawing

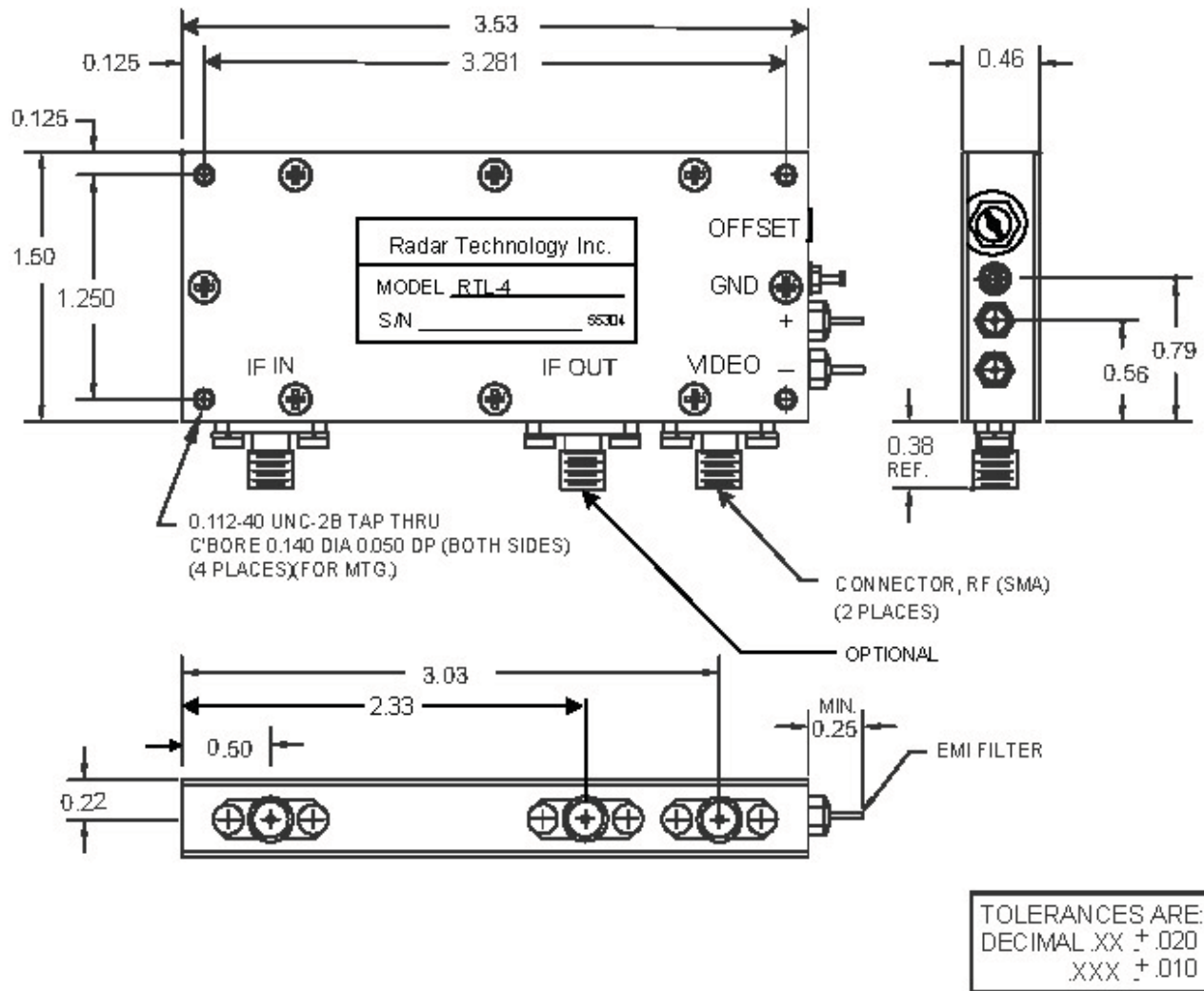

Notes:

1. Chassis material is AL alloy per QQ-A-250 with yellow iridite finish per MIL-C-5541.
2. Top cover is AL alloy, finish semigloss black enamel with white markings approximately as shown.
3. Bottom cover is Kovar with nickel/gold finish.
4. All semiconductor devices contained within the unit are hermetically sealed, but overall unit is not.
5. The substrate and discrete components are conformally coated.

Logarithmic Hybrid Amplifiers

The RTLX-4 series is a premium version of RTI's standard RTL-4 series for use in systems where logarithmic accuracy is critical. All the key features which have made the RTL-4 series an industry standard - size, reliability, and performance - have been combined with a typical log accuracy of less than 0.3dB to produce the RTLX-4.

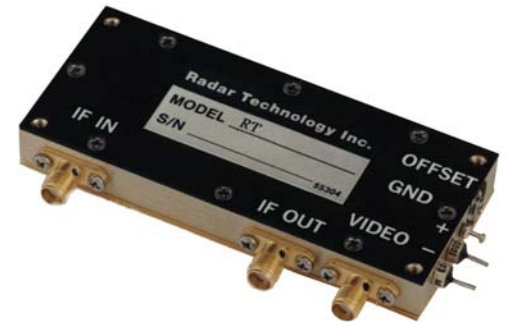

General Specifications

Linearity	±0.5 dB (add ±0.5 dB over Temperature) (-30°C to +71°C)
SENSITIVITY	25mV/dB (typ)
SOURCE IMPEDANCE	50 Ohms
VIDEO LOAD IMPEDANCE	93 Ohms
POWER REQUIREMENTS	± 15 VDC
CONNECTORS	SMA

Key Features

- 80dB Dynamic Range
- ± 1 dB Linearity
(add ±0.5 dB over Temperature)
- DC Coupled Video
- Built-in Voltage Regulation
- Excellent Pulse Response

Optional Specifications

Limited IF Output	0 dBm (add suffix B) or 10 dBm (add suffix B+)
Power Supplies	± 12V DC (add suffix C)
Matched Set	2,3 units/set (add suffix M)

Design Note: Radar Technology can customize any of our products to meet your individual system requirements. RTI also offers many form, fit, function replacements to old RHG Electronics Amplifiers.

Specification Table

Model	Center Frequency (MHz)	Bandwidth (MHz)	Rise Time (uS)	Dynamic Range (dB)	Input Power (dBm)
RTLX-4-1003	10	3	0.5	80	-80 to 0
RTLX-4-3002	30	2	0.5	80	-80 to 0
RTLX-4-3004	30	4	0.25	80	-80 to 0
RTLX-4-3010	30	4	0.1	80	-80 to 0
RTLX-4-4510	45	10	0.1	80	-80 to 0
RTLX-4-6010	60	10	0.1	80	-80 to 0
RTLX-4-6020	60	20	0.05	80	-80 to 0
RTLX-4-7010	70	10	0.1	80	-80 to 0
RTLX-4-7020	70	20	0.05	80	-80 to 0
RTLX-4-12020	120	20	0.05	70	-70 to 0
RTLX-4-12040	120	40	0.03	70	-70 to 0
RTLX-4-16020	160	20	0.05	70	-70 to 0
RTLX-4-16030	160	30	0.04	70	-70 to 0
RTLX-4-16040	160	40	0.03	70	-70 to 0

*Parameters can be modified to meet specific application requirements

Outline Drawing

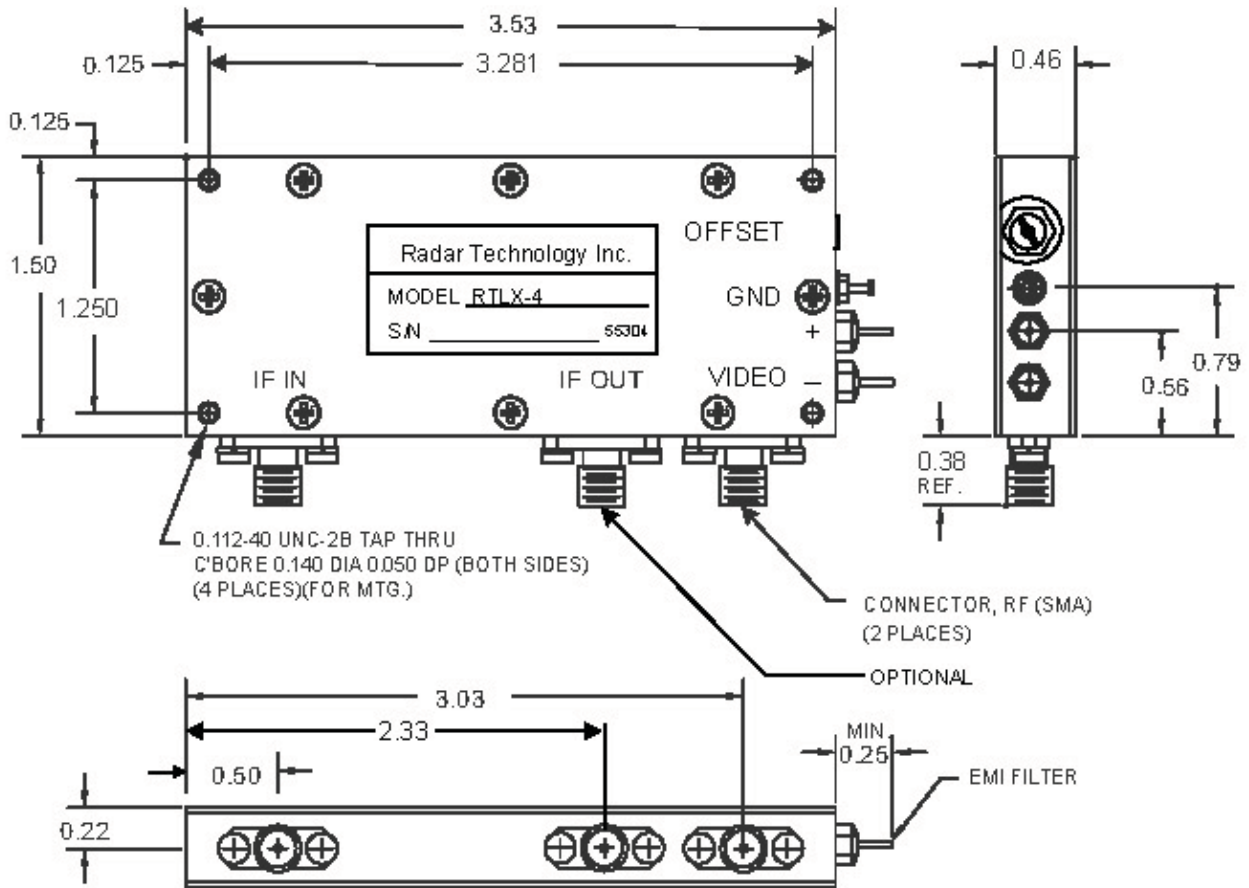

TOLERANCES ARE:
 DECIMAL .XX[±] .020
 .XXX[±] .010

Notes:

1. Chassis material is AL alloy per QQ-A-250 with yellow iridite finish per MIL-C-5541.
2. Top cover is AL alloy, finish semigloss black enamel with white markings approximately as shown.
3. Bottom cover is Kovar with nickel/gold finish.
4. All semiconductor devices contained within the unit are hermetically sealed, but overall unit is not.
5. The substrate and discrete components are conformally coated.

Wideband Log Amplifiers

RTI has developed a series of high performance wideband log amplifiers that cover broad operating frequency ranges. The RTLWB-4 series provide excellent log accuracy and pulse performance over wide bandwidths. Slope variations of less than 10% are typical.



Key Features

- Wide Band Operating Frequencies
- 60-70 dB Dynamic Range
- ± 1.0 dB Linearity
- DC Coupled Video
- Excellent Pulse Response

General Specifications

Linearity	± 1.0 dB (add ± 0.5 dB over Temperature) (-30°C to +71°C) (add ± 0.5 dB over Bandwidth)
Sensitivity	25mV/dB (typ)
Source Impedance	50 Ohms
Video Load Impedance	93 Ohms
Power Requirements	± 15 VDC

Optional Specifications

Limited IF Output	0 dBm (add suffix B)
Power Supplies	± 12 V DC (add suffix C)
Matched Set	2,3 units/set (add suffix M)

Design Note: Radar Technology can customize any of our products to meet your individual system requirements. RTI also offers many form, fit, function replacements to old RHG Electronics Amplifiers.

Specification Table

Model	Center Frequency (MHz)	Bandwidth (MHz)	Rise Time (μ S)	Dynamic Range (dB)	Input Power (dBm)
RTLWB-4-150	150	100	25	70	-70 to 0
RTLWB-4-160	160	100	25	70	-70 to 0
RTLWB-4-300	300	200	15	70	-70 to 0
RTLWB-4-500	500	200	15	60	-60 to 0
RTLWB-4-750	750	300	10	60	-60 to 0
RTLWB-4-1000	1000	500	10	60	-60 to 0

*Parameters can be modified to meet specific application requirements

Outline Drawing

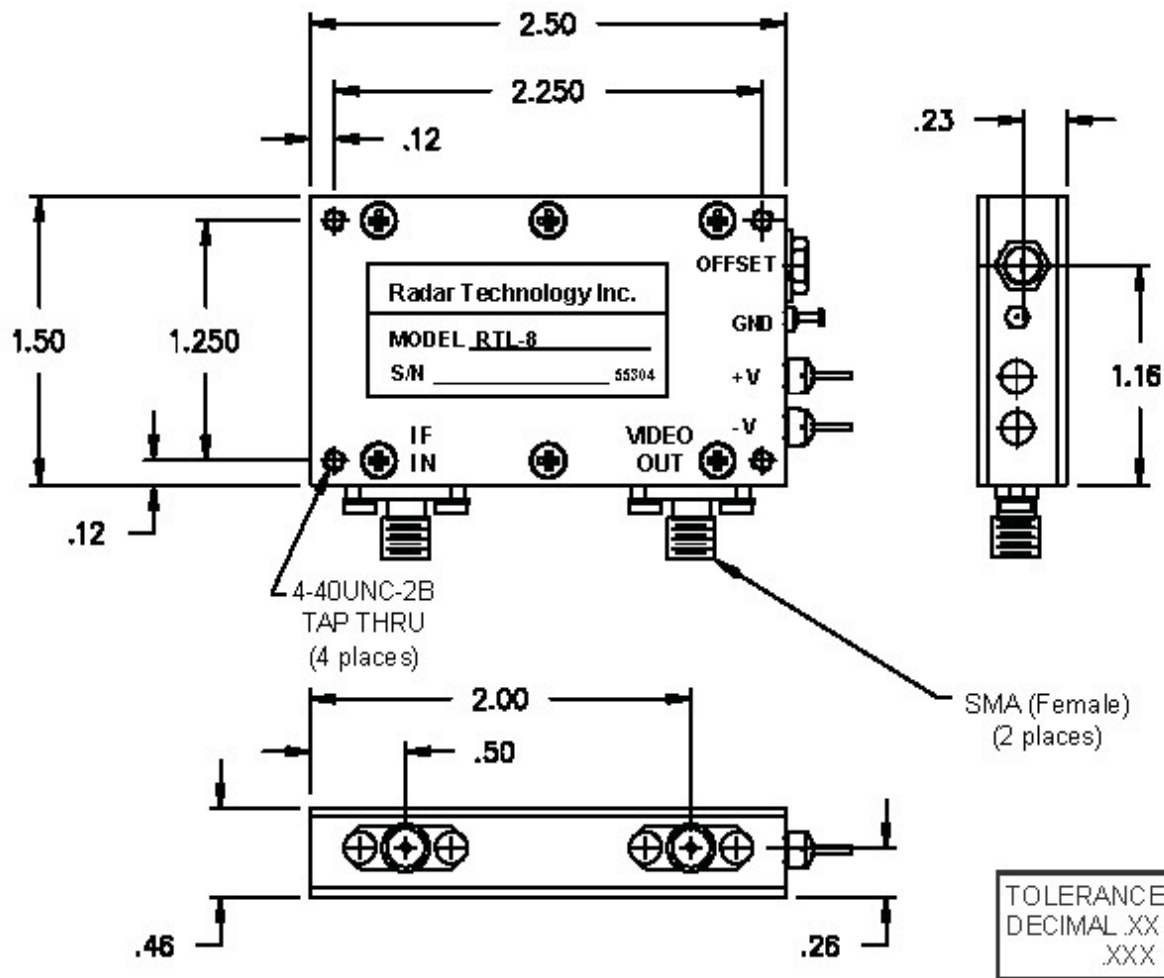

Notes:

1. Chassis material is AL alloy per QQ-A-250 with yellow iridite finish per MIL-C-5541.
2. Top cover is AL alloy, finish semigloss black enamel with white markings approximately as shown.
3. Bottom cover is Kovar with nickel/gold finish.
4. The substrate and discrete components are conformally coated.

Hermetic Sealed Log Amplifiers

RTI has developed a series of hybrid log amplifiers that are small in size, light in weight, and high on reliability. These units are hermetically sealed devices with 50 Ohm PCB mountable pins. The amplifiers are available in a variety of chassis packages and are designed to meet MIL-STD-5400 and MIL-STD-16400 environments and can be cycled to MIL-STD 883, Method 1010, Condition A.



General Specifications

Linearity	± 1 dB (add ± 0.5 dB over Temperature) (-30°C to +71°C)
Sensitivity	25mV/dB (typ)
Source Impedance	50 Ohms
Video Load Input	93 Ohms
Power Requirements	± 15 V DC
Connectors	PCB Mountable Pins

Key Features

- Hermetically Sealed
- PCB Mountable
- 80dB Dynamic Range
- ± 1 dB Linearity

Optional Specifications

Limited IF Output	0 dBm (add suffix B) or 10 dBm (add suffix B+)
Power Supplies	± 12 VDC (add suffix C)
Matched Set	2, 3 units/set (add suffix M)

Design Note: Radar Technology can customize any of our products to meet your individual system requirements. RTI also offers many form, fit, function replacements to old RHG Electronics Amplifiers.

Specification Table

Model	Center Frequency (MHz)	Bandwidth (MHz)	Rise Time (μ S)	Dynamic Range (dB)	Input Power (dBm)
RTL-6-1003	10	3	0.5	80	-80 to 0
RTL-6-3002	30	2	0.5	80	-80 to 0
RTL-6-3004	30	4	0.25	80	-80 to 0
RTL-6-3010	30	10	0.1	80	-80 to 0
RTL-6-4510	45	10	0.1	80	-80 to 0
RTL-6-6010	60	10	0.1	80	-80 to 0
RTL-6-6020	60	20	0.05	80	-80 to 0
RTL-6-7010	70	10	0.1	80	-80 to 0
RTL-6-7020	70	20	0.05	80	-80 to 0
RTL-6-12020	120	20	0.05	70	-70 to 0
RTL-6-12040	120	40	0.03	70	-70 to 0
RTL-6-16020	160	20	0.05	70	-70 to 0
RTL-6-16030	160	30	0.04	70	-70 to 0
RTL-6-16040	160	40	0.03	70	-70 to 0

Outline Drawing

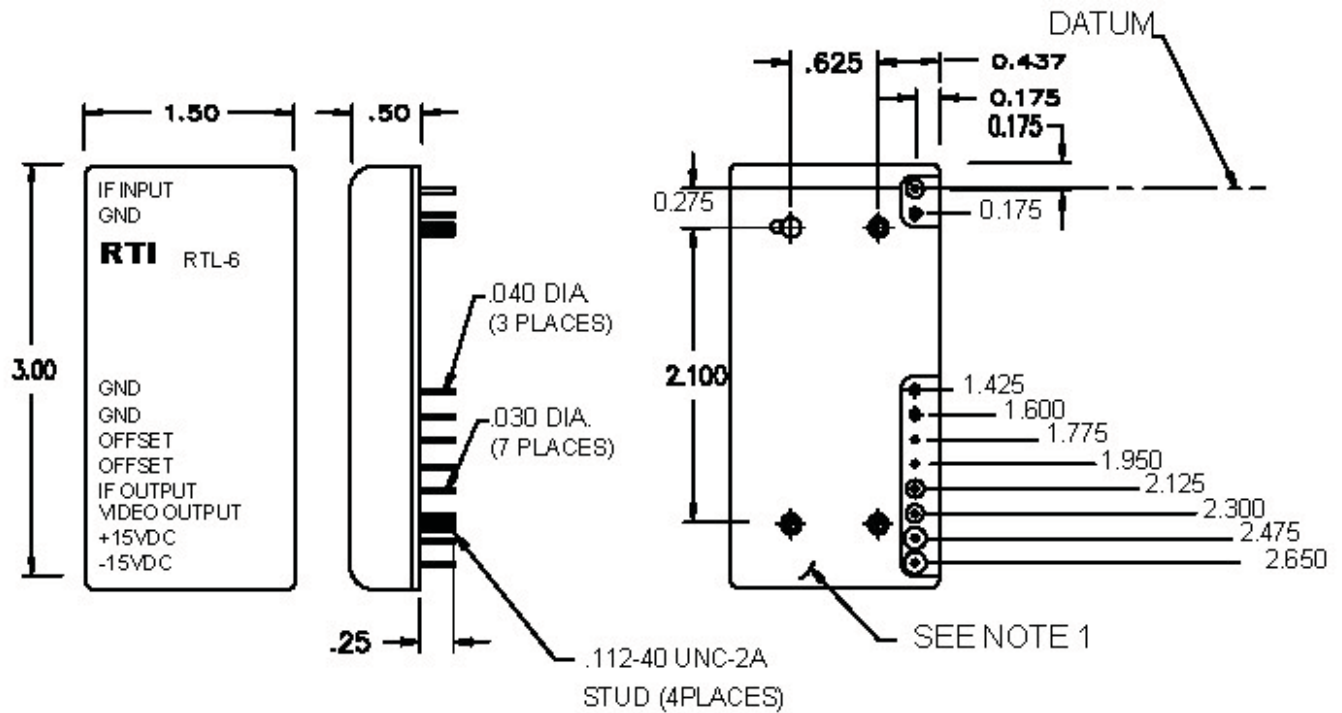

TOLERANCES ARE:
 DECIMAL .XX ±.020
 .XXX ±.010

Notes:

1. This surface should be in direct contact with the mounting surface.

Logarithmic Amplifiers

RTI has developed a series of low cost and easily customized log amplifiers, available in frequency range from DC to 3 GHz.

General Specifications

Slope	25 mV/dB (typical)
Source Impedance	50 Ohms
Video Load Impedance	93 Ohms
Power Requirements	±15 VDC
Connectors	SMA
Connectors	PCB Mountable Pins



Optional Specifications

Customized video load, slope
±12 VDC power supplies
Single power supply

Design Note: Radar Technology can customize any of our products to meet your individual system requirements. RTI also offers many form, fit, function replacements to old RHG Electronics Amplifiers.

Specification Table

Model	Frequency (MHz)	Rise Time (nS)	Linearity at 25° C (dB)	Input Power (dBm)
RTL-7-10	10	200	1	-70 to +10
RTL-7-30	30	100	1	-70 to +10
RTL-7-45	45	100	1	-70 to +10
RTL-7-60	60	100	1	-70 to +10
RTL-7-70	70	100	1	-70 to +10
RTL-7-120	120	100	1	-70 to +10
RTL-7-160	160	100	1	-70 to +10
RTL-7-200	200	100	1	-70 to +10
RTL-7-300	300	100	1	-70 to +10
RTL-7-100-2500	100-2500	40	1.5	-65 to 0

*Parameters can be modified to meet specific application requirements

Logarithmic Hybrid Amplifiers

RTI has developed a series of hybrid log amplifiers that are 30% smaller than our RTL-4 Series without sacrificing the electrical performance characteristics found in the RTL-4 series log amplifiers.

Key Features

- 80dB Dynamic Range
- ± 1 dB Linearity
- DC Coupled Video
- Built-in Voltage Regulation
- Excellent Pulse Response



General Specifications

Linearity	± 1 dB (add ± 0.5 dB over Temperature) (-30°C to $+71^{\circ}\text{C}$)
Sensitivity	25mV/dB (typ)
Source Impedance	50 Ohms
Video Load Impedance	93 Ohms
Power Requirements	± 15 VDC
Connectors	SMA

Optional Specifications

Limited IF Output	0 dBm (add suffix B)
Power Supplies	$\pm 12\text{V}$ DC (add suffix C)
Matched Set	2,3 units/set (add suffix M)

Design Note: Radar Technology can customize any of our products to meet your individual system requirements. RTI also offers many form, fit, function replacements to old RHG Electronics Amplifiers.

Specification Table

Model	Center Frequency (MHz)	Bandwidth (MHz)	Rise Time (μs)	Dynamic Range (dB)	Input Power (dBm)
RTL-8-1003	10	3	0.5	80	-80 to 0
RTL-8-3002	30	2	0.5	80	-80 to 0
RTL-8-3004	30	4	0.25	80	-80 to 0
RTL-8-3010	30	10	0.1	80	-80 to 0
RTL-8-4510	45	10	0.1	80	-80 to 0
RTL-8-6010	60	10	0.1	80	-80 to 0
RTL-8-6020	60	20	0.05	80	-80 to 0
RTL-8-7010	70	10	0.1	80	-80 to 0
RTL-8-7020	70	20	0.05	80	-80 to 0
RTL-8-12020	120	20	0.05	70	-70 to 0
RTL-8-12040	120	40	0.03	70	-70 to 0
RTL-8-16020	160	20	0.05	70	-70 to 0
RTL-8-16030	160	30	0.04	70	-70 to 0
RTL-8-16040	160	40	0.03	70	-70 to 0

Outline Drawing

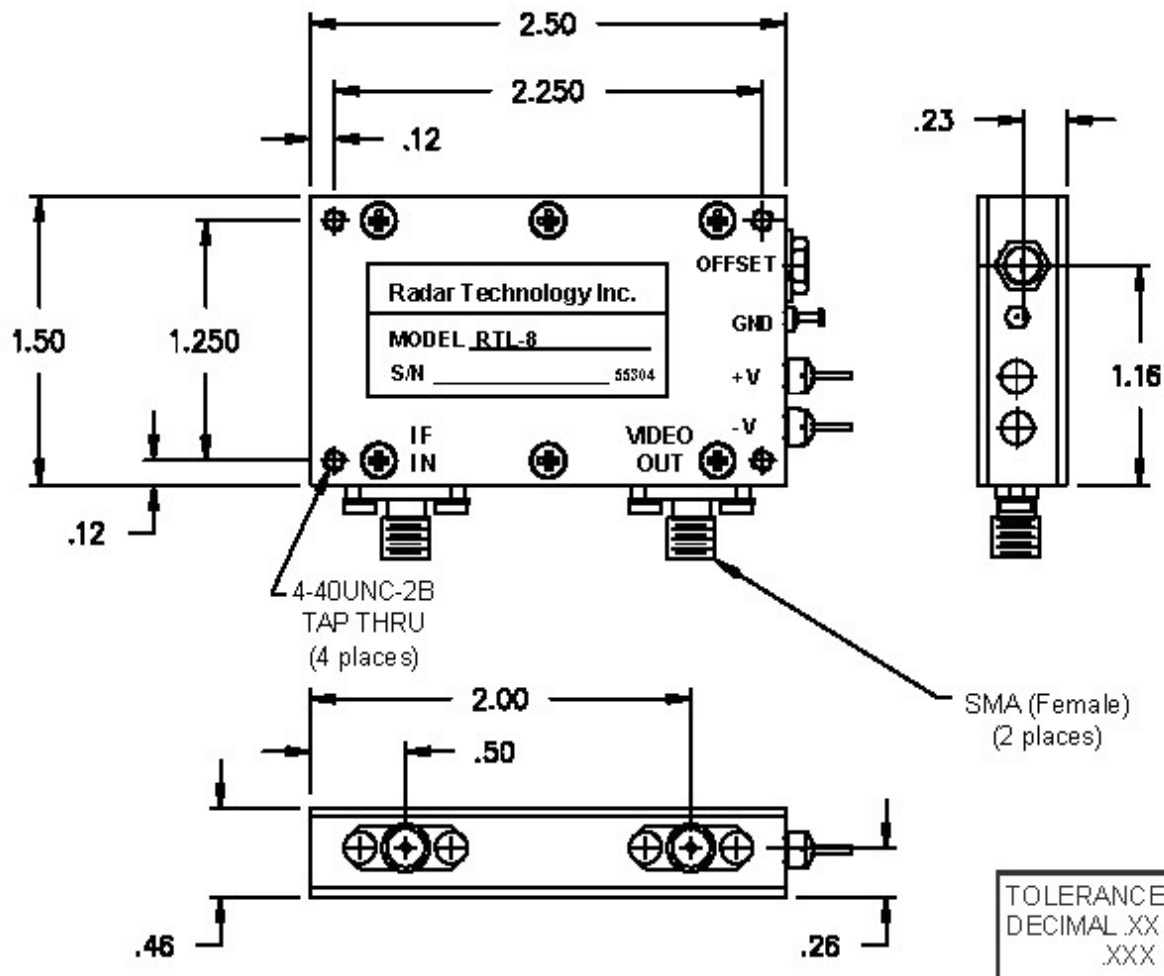

Notes:

1. Chassis material is AL alloy per QQ-A-250 with yellow iridite finish per MIL-C-5541.
2. Top cover is AL alloy, finish semigloss black enamel with white markings approximately as shown.
3. Bottom cover is Kovar with nickel/gold finish.
4. The substrate and discrete components are conformally coated.

Linear Hybrid Amplifiers

RTI has developed a series of linear amplifiers that offer excellent linearity with exceptionally wide dynamic range. By providing adequate gain, these amplifiers are able to boost the levels of CW and pulsed signals for additional IF or video signal processing.

Key Features

- 10-1000MHz Frequency Range
- 60-70dB Gain
- Gain Control
- Low Noise

General Specifications

Gain Control	50dB (min)
Gain Control Voltage	0 to -4V (nom)
Source Impedance	50 Ohms
Video Load Impedance	93 Ohms
Temperature Range	-30°C to +71°C
Connectors	SMA

Specification Table

Model	Center Frequency (MHz)	Bandwidth (MHz)	Noise Figure (dB)	Dynamic Range (dB)	Power Supply(V DC)
RTA-4-1003	10	3	4	70	-15
RTA-4-3002	30	2	4	70	-15
RTA-4-3010	30	10	4	70	-15
RTA-4-6010	60	10	4	70	-15
RTA-4-6020	60	20	4	70	-15
RTA-4-7010	70	10	4	70	-15
RTA-4-7020	70	20	4	70	-15
RTA-4-12020	120	20	5	60	-15
RTA-4-12040	120	40	5	60	-15
RTA-4-16020	160	20	5	60	-15
RTA-4-16040	160	40	5	60	-15
RTA-4-300	300	200	5	60	±15
RTA-4-500	500	200	5	60	±15
RTA-4-750	750	300	5	60	±15
RTA-4-1000	1000	500	5	60	±15

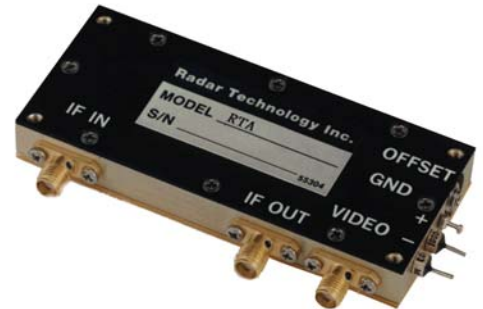

Design Note: Radar Technology can customize any of our products to meet your individual system requirements. RTI also offers many form, fit, function replacements to old RHG Electronics Amplifiers.

Optional Specifications

DC Coupled Video Output	(add suffix D)(requires ±15V DC)
Power Supplies	±12V DC (add suffix C)
Matched Set:(Gain/Phase)	2,3 units/set (add suffix M)

*Parameters can be modified to meet specific application requirements

Outline Drawing

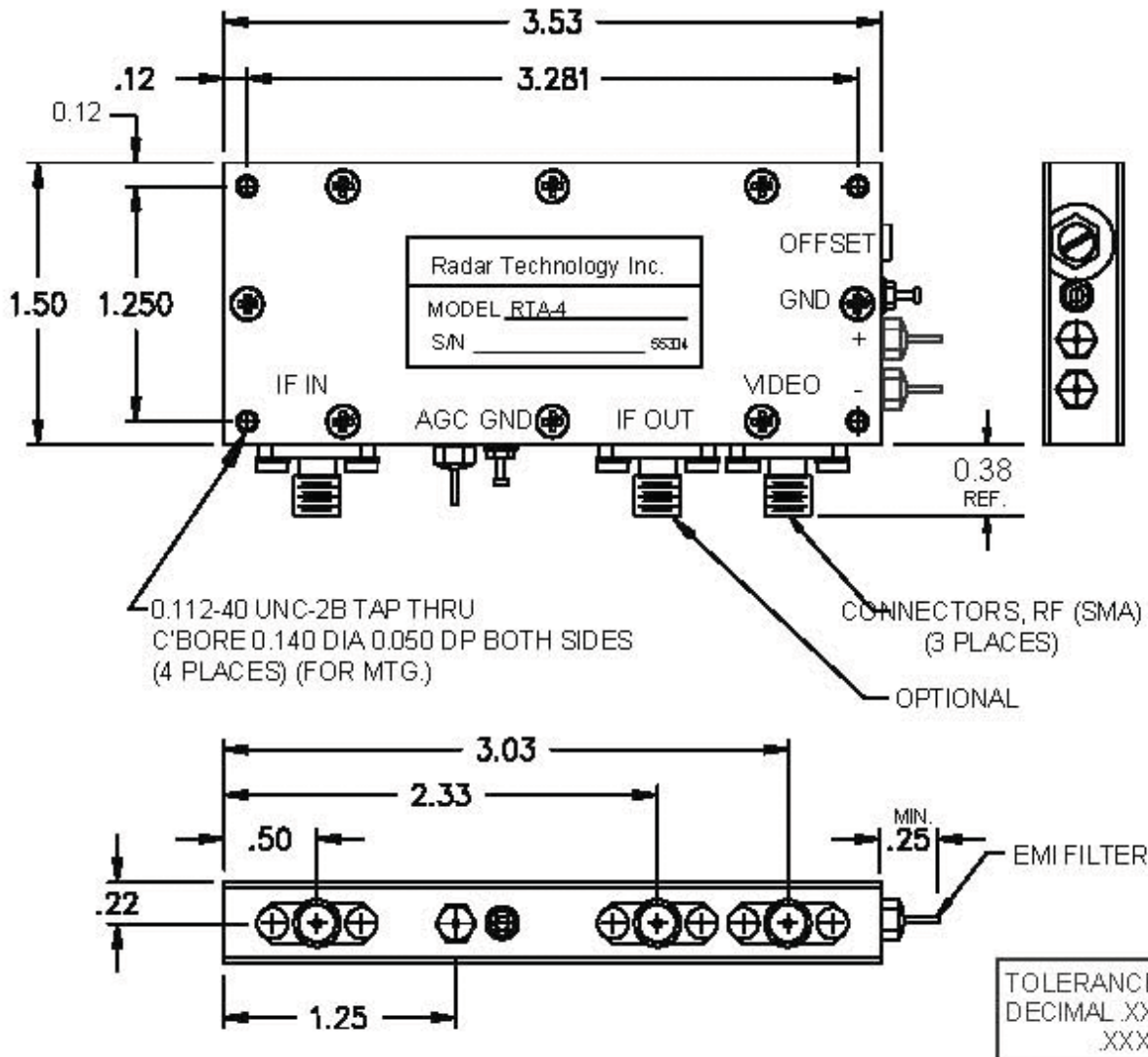

Notes:

1. Chassis material is AL alloy per QQ-A-250 with yellow iridite finish per MIL-C-5541.
2. Top cover is AL alloy, finish semigloss black enamel with white markings approximately as shown.
3. Bottom cover is Kovar with nickel/gold finish.
4. All semiconductor devices contained within the unit are hermetically sealed, but overall unit is not.
5. The substrate and discrete components are conformally coated.

Linear Hybrid Amplifiers

RTI has developed a series of linear amplifiers that offer excellent linearity with exceptionally wide dynamic range. By providing adequate gain, these amplifiers are able to boost the levels of CW and pulsed signals for additional IF or video signal processing.

Key Features

- 10-1000MHz Frequency Range
- 60-70dB Gain
- Gain Control
- Low Noise



Design Note: Radar Technology can customize any of our products to meet your individual system requirements. RTI also offers many form, fit, function replacements to old RHG Electronics Amplifiers.

General Specifications

Gain Control	50dB (min)
Gain Control Voltage	0 to -4V (nom)
Source Impedance	50 Ohms
Video Load Impedance	93 Ohms
Temperature Range	-30°C to +71°C
Power Requirements	+15V DC
Connectors	SMA

Optional Specifications

DC Coupled Video Output	(add suffix D)(requires ±15V DC)
Power Supplies	±12V DC (add suffix C)
Matched Set:(Gain/Phase)	2,3 units/set (add suffix M)

Specification Table

Model	Center Frequency (MHz)	Bandwidth (MHz)	Noise Figure (dB)	Dynamic Range (dB)	Power Supply(V DC)
RTA-5-1003	10	3	4	70	+15
RTA-5-3002	30	2	4	70	+15
RTA-5-3010	30	10	4	70	+15
RTA-5-6010	60	10	4	70	+15
RTA-5-6020	60	20	4	70	+15
RTA-5-7010	70	10	4	70	+15
RTA-5-7020	70	20	4	70	+15
RTA-5-12020	120	20	5	60	+15
RTA-5-12040	120	40	5	60	+15
RTA-5-16020	160	20	5	60	+15
RTA-5-16040	160	40	5	60	+15

*Parameters can be modified to meet specific application requirements

Outline Drawing

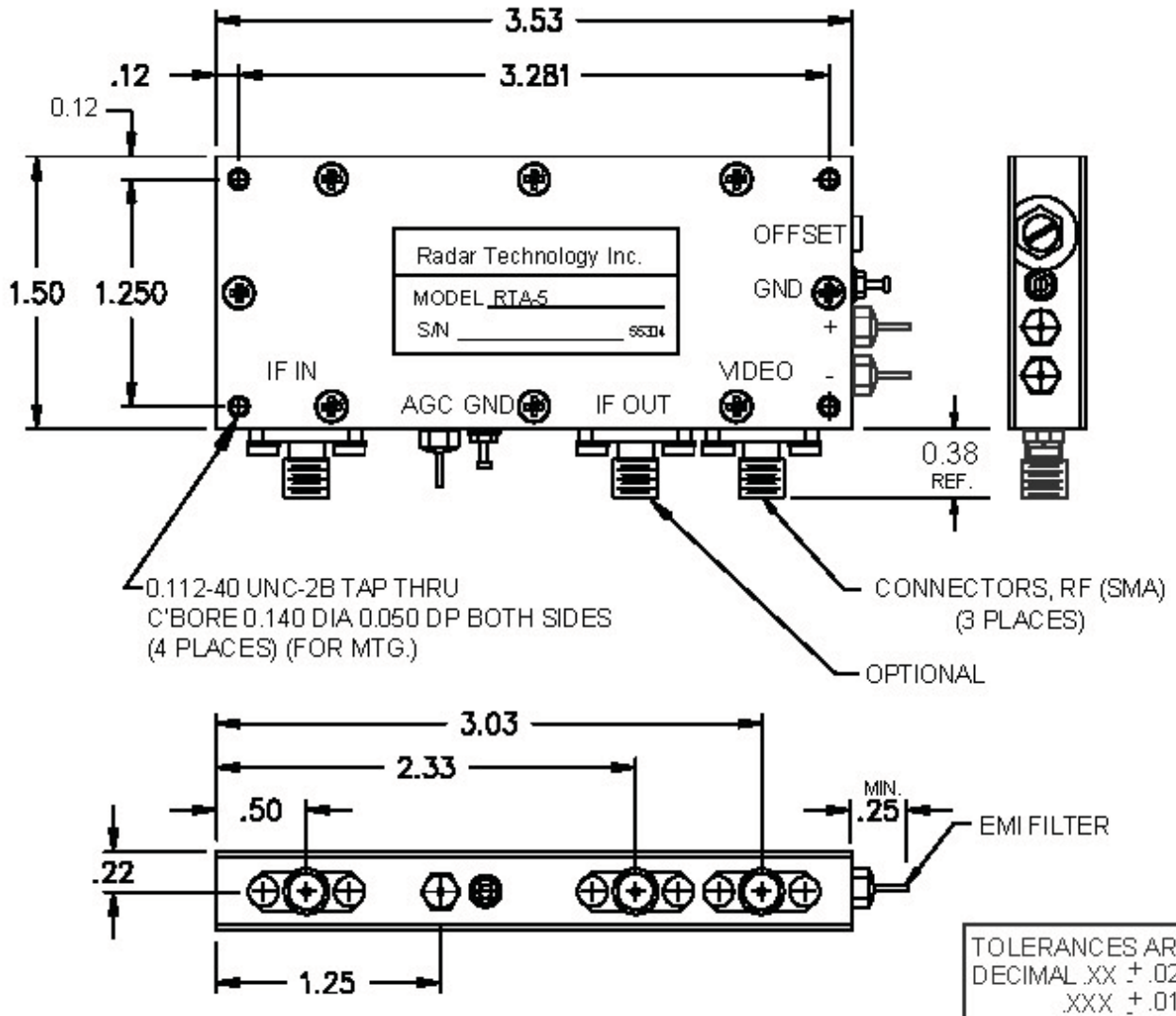

Notes:

1. Chassis material is AL alloy per QQ-A-250 with yellow iridite finish per MIL-C-5541.
2. Top cover is AL alloy, finish semigloss black enamel with white markings approximately as shown.
3. Bottom cover is Kovar with nickel/gold finish.
4. All semiconductor devices contained within the unit are hermetically sealed, but overall unit is not.
5. The substrate and discrete components are conformally coated.

Hybrid Preamplifiers

RTI has developed a series of hybrid preamplifiers that offer excellent low noise performance coupled with wide dynamic range.



Key Features

- 10-1000MHz Frequency Range
- 30dB Gain / Low Noise
- Available STC Option

Design Note: Radar Technology can customize any of our products to meet your individual system requirements. RTI also offers many form, fit, function replacements to old RHG Electronics Amplifiers.

General Specifications

Source Impedance	50 Ohms
Load Impedance	50 Ohms
Temperature Range	-30°C to +71°C
Power Requirements	+15 VDC or -15 VDC
Connectors	SMA

Optional Specifications

Power Supplies	±12V DC (add suffix C)
STC Gain Control	0 to 4V (add suffix STC)

Specification Table

Model	Center Frequency (MHz)	Bandwidth (MHz)	Noise Figure (dB)	Gain (dB)	1 dB Compression (dBm min)
RTPA-5-1003	10	3	2.5	30	+10
RTPA-5-3010	30	10	2.5	30	+10
RTPA-5-6010	60	10	2.5	30	+10
RTPA-5-7010	70	10	2.5	30	+10
RTPA-5-12020	120	20	3.0	30	+10
RTPA-5-16040	160	40	3.0	30	+10
RTPA-5-300	300	50	3.0	30	+10
RTPA-5-500	500	100	5.0	30	+10
RTPA-5-750	750	200	5.0	30	+10
RTPA-5-1000	1000	500	5.0	30	+10

*Parameters can be modified to meet specific application requirements

Outline Drawing

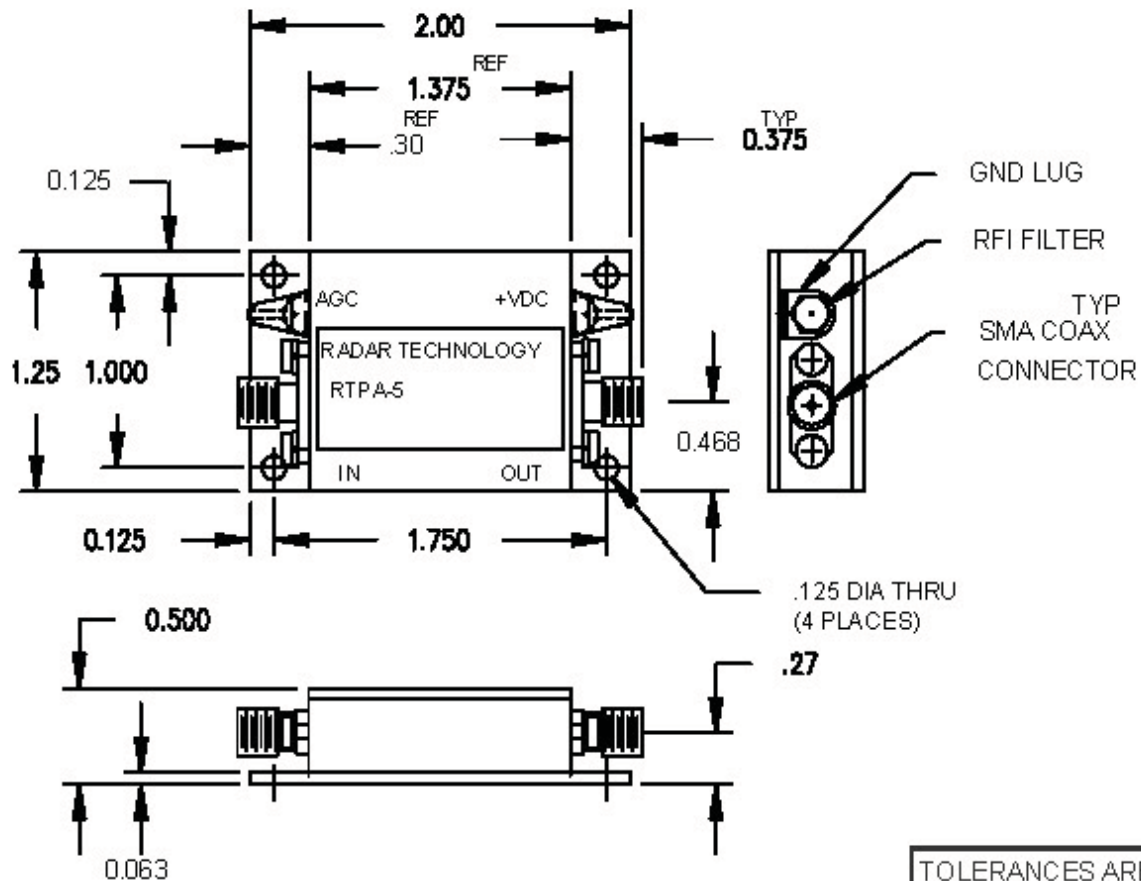

TOLERANCES ARE:
 DECIMAL .XX \pm .020
 .XXX \pm .010

Notes:

1. Chassis material and covers are AL alloy per QQ-A-250 with yellow iridite finish per MIL-C-5541.

Linear Hybrid Amplifiers

For the system that needs it all, RTI has developed the RTSA series. This linear amplifier combines all the features found in the RTA-4, with closed loop AGC. To optimize closed loop operation, pulse width and PRF should be specified at time of order. Optional features available include IAGC, blanking and FTC. Please contact the factory for details on optional specifications.



Key Features

- 10-1000MHz Frequency Range
- MGC and Closed Loop AGC
- Low Noise

Design Note: Radar Technology can customize any of our products to meet your individual system requirements. RTI also offers many form, fit, function replacements to old RHG Electronics Amplifiers.

General Specifications

Gain Control	50dB (min)
Gain Control Voltage	0 to -4V (nom)
Source Impedance	50 Ohms
Video Load Impedance	93 Ohms
Temperature Range	-30°C to +71°C
Power Requirements	±15V DC
Connectors	SMA

Optional Specifications

DC Coupled Video Output	(add suffix D)
Power Supplies	±12V DC (add suffix C)
Matched Set:(Gain/Phase)	2,3 units/set (add suffix M)

Specification Table

Model	Center Frequency (MHz)	Bandwidth (MHz)	Noise Figure (dB)	Dynamic Range (dB)
RTSA-1003	10	3	4	70
RTSA-3002	30	2	4	70
RTSA-3010	30	10	4	70
RTSA-6010	60	10	4	70
RTSA-6020	60	20	4	70
RTSA-7010	70	10	4	70
RTSA-7020	70	20	4	70
RTSA-12020	120	20	5	60
RTSA-12040	120	40	5	60
RTSA-16020	160	20	5	60
RTSA-16040	160	40	5	60
RTSA-300	300	200	5	60
RTSA-500	500	200	5	60
RTSA-750	750	300	5	60
RTSA-1000	1000	500	5	60

Outline Drawing

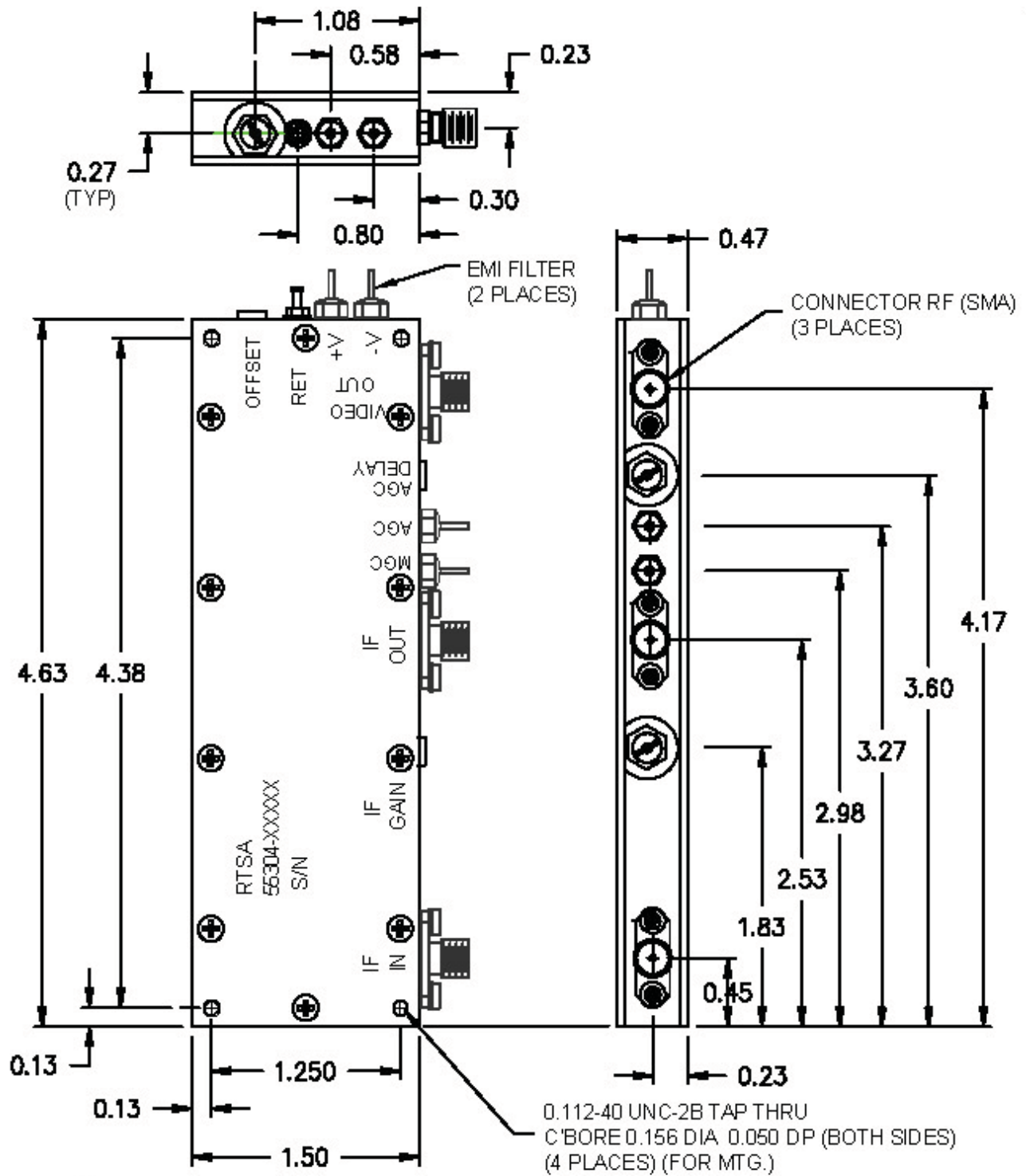

TOLERANCES ARE:
DECIMAL .XX ±.020
XXX ±.010

Notes:

1. Chassis material is AL alloy per QQ-A-250 with yellow iridite finish per MIL-C-5541.
2. Top cover is AL alloy, finish semigloss black enamel with white markings approximately as shown.

Hybrid Limiter Discriminators

RTI has developed a series of hybrid limiter discriminators that provide accurate FM demodulation of very high speed pulsed IF signals. The RTD-4 series has been designed for systems using fast pulses of short duration with transient distortion of pulse edges greatly reduced.

Key Features

- 30 MHz to 3GHz Frequency Range
- $< \pm 5\%$ Linearity
- Excellent Pulse Fidelity



General Specifications

Linearity	$< \pm 5\%$ (at 0dBm)
Source Impedance	50 Ohms
Load Impedance	93 Ohms
Temperature Range	-30°C to $+71^{\circ}\text{C}$
Power Requirements	± 15 VDC
Connectors	SMA

Design Note: Radar Technology can customize any of our products to meet your individual system requirements. RTI also offers many form, fit, function replacements to old RHG Electronics Amplifiers.

Optional Specifications

Power Supplies	$\pm 12\text{V}$ DC (add suffix C)
----------------	------------------------------------

Specification Table

Model	Center Frequency (MHz)	Peak to Peak Bandwidth (MHz)	Linear Bandwidth (MHz)	Rise Time (nsec)	Video Output (mV/MHz)	Input Level Range (dBm)
RTD-4-30	30	20	10	125	100	-20 to 0
RTD-4-60	60	30	15	70	50	-20 to 0
RTD-4-70	70	30	20	70	50	-20 to 0
RTD-4-160	160	100	50	25	25	-20 to 0
RTD-4-300	300	200	100	25	25	-10 to 0
RTD-4-500	500	250	150	25	25	-10 to 0
RTD-4-750	750	400	250	25	15	-10 to 0
RTD-4-1000	1000	500	500	25	10	-10 to 0
RTD-4-2000	2000	300	200	25	20	-10 to 0
RTD-4-3000	3000	300	200	25	20	-10 to 0

*Parameters can be modified to meet specific application requirements

Outline Drawing

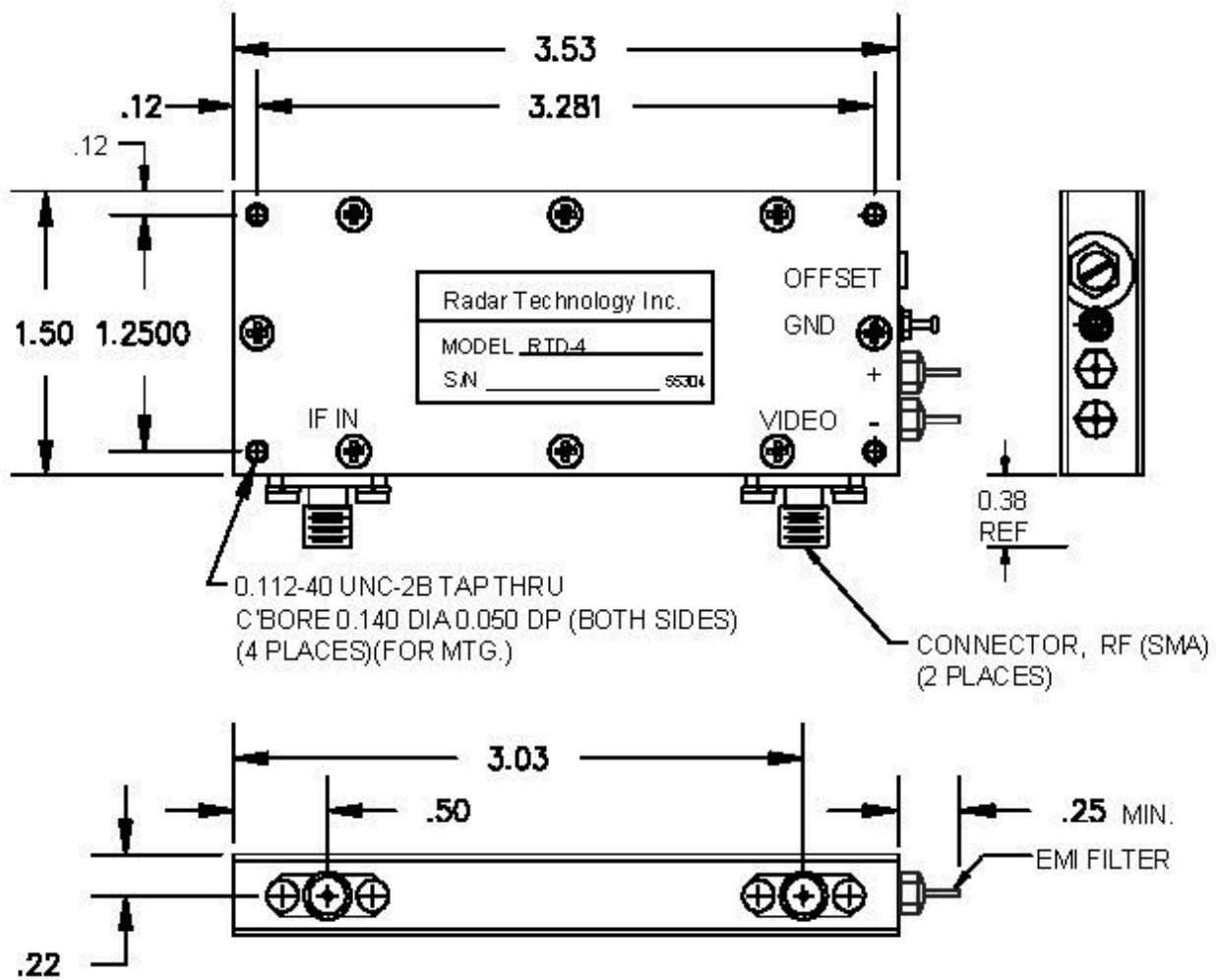

Notes:

1. Chassis material is AL alloy per QQ-A-250 with yellow iridite finish per MIL-C-5541.
2. Top cover is AL alloy, finish semigloss black enamel with white markings approximately as shown.
3. Bottom cover is Kovar with nickel/gold finish.
4. All semiconductor devices contained within the unit are hermetically sealed, but overall unit is not.
5. The substrate and discrete components are conformally coated.

Hermetic Limiter Discriminators

RTI has developed a series of hybrid limiter discriminators that provide accurate FM demodulation of very high speed, pulsed IF signals. The RTD-6 series has been designed for systems using fast pulses of short duration with transient distortion of pulse edges greatly reduced. These units are available in the 30 MHz to 1 GHz frequency range, with PC mountable pins.



Key Features

- 30 MHz to 1GHz Frequency Range
- Hermetically Sealed PCB Mountable
- $<\pm 5\%$ Linearity

Optional Specifications

Power Supplies

$\pm 12V$ DC (add suffix C)

General Specifications

Linearity	$<\pm 5\%$ (at 0dBm)
Source Impedance	50 Ohms
Load Impedance	93 Ohms
Temperature Range	$-30^{\circ}C$ to $+71^{\circ}C$
Power Requirements	± 15 VDC

Design Note: Radar Technology can customize any of our products to meet your individual system requirements. RTI also offers many form, fit, function replacements to old RHG Electronics Amplifiers.

Specification Table

Model	Center Frequency (MHz)	Peak to Peak Bandwidth (MHz)	Linear Bandwidth (MHz)	Rise Time (nsec)	Video Output (mV/MHz)	Input Level Range (dBm)
RTD-6-30	30	20	10	125	100	-20 to 0
RTD-6-60	60	30	15	70	50	-20 to 0
RTD-6-70	70	30	20	70	50	-20 to 0
RTD-6-160	160	100	50	25	25	-20 to 0
RTD-6-300	300	200	100	25	25	-10 to 0
RTD-6-500	500	250	150	25	25	-10 to 0
RTD-6-750	750	400	250	25	15	-10 to 0
RTD-6-1000	1000	500	500	25	10	-10 to 0

*Parameters can be modified to meet specific application requirements

Outline Drawing

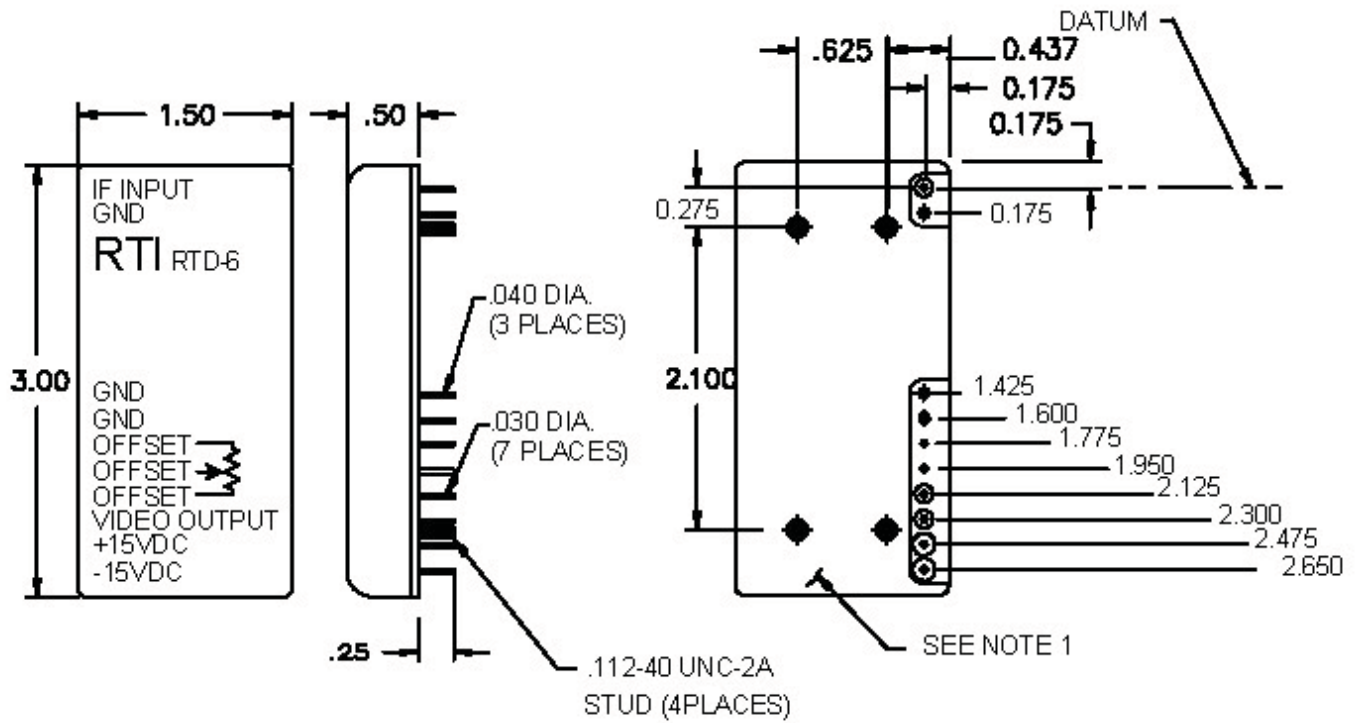

Notes:

1. This surface should be in direct contact with the mounting surface.

TOLERANCES ARE:
 DECIMAL .XX ±.020
 .XXX ±.010

Automatic frequency control

RTDAFC Amplifier/Discriminator accept pulsed signals and provide a DC output voltage which is a monotonic function of the frequency error.



Key Features

- 30 MHz to 160 MHz Frequency Range
- Stable output

Optional Specifications

Power Supplies	±12V DC (add suffix C)
Negative Transfer Slope	add suffix N

General Specifications

INPUT PULSE REPETITION	100 Hz to 10 KHz
SOURCE IMPEDANCE	50 Ohms
TEMPERATURE RANGE	-30°C to +71°C
LOAD IMPEDANCE	1 KOhms
POWER REQUIREMENTS	± 15 VDC
CONNECTORS	SMA

Design Note: Radar Technology can customize any of our products to meet your individual system requirements. RTI also offers many form, fit, function replacements to old RHG Electronics Amplifiers.

Specification Table

Model	Center Frequency (MHz)	Peak to Peak Bandwidth (MHz)	Pulse Width (nsec)	Input Level Range (dBm)
RTDAFC-30	30	20	300	-10 to 0
RTDAFC-60	60	40	150	-10 to 0
RTDAFC-160	160	60	100	-10 to 0

*Parameters can be modified to meet specific application requirements

The RTIQ Series of I/Q detectors was developed by RTI to measure the amplitude and phase of an IF input signal relative to a fixed level (Ref) signal.

Key Features

- 10-350MHz Frequency Range



General Specifications

Required Reference Signal	Input Level: +13 ±1dBm
Max. Ev Input Level	(for 1dB saturation): +13dBm
Source Impedance	50 Ohms
Video Load Impedance	75 Ohms
Gain (K)	3.5 ±.35V
Dynamic Range	-20 to 0dBm
Power Requirements	± 15VDC
Connectors	SMA

Design Note: Radar Technology can customize any of our products to meet your individual system requirements. RTI also offers many form, fit, function replacements to old RHG Electronics Amplifiers.

Optional Specifications

Power Supplies	±12V DC (add suffix C)
Temperature Range	-30 to +71° C

Specification Table

Model	Center Frequency (MHz)	Information Bandwidth (MHz)	Accuracy Bandwidth (MHz)	Settling Time (uS)	Angular Accuracy (Deg.)
RTIQ-3010	30	10	2	0.1	±5
RTIQ-6020	60	20	4	0.08	±5
RTIQ-7020	70	20	4	0.08	±5
RTIQ-16020	160	20	4	0.08	±5
RTIQ-35020	350	20	6	0.05	±5

*Parameters can be modified to meet specific application requirements

Outline Drawing

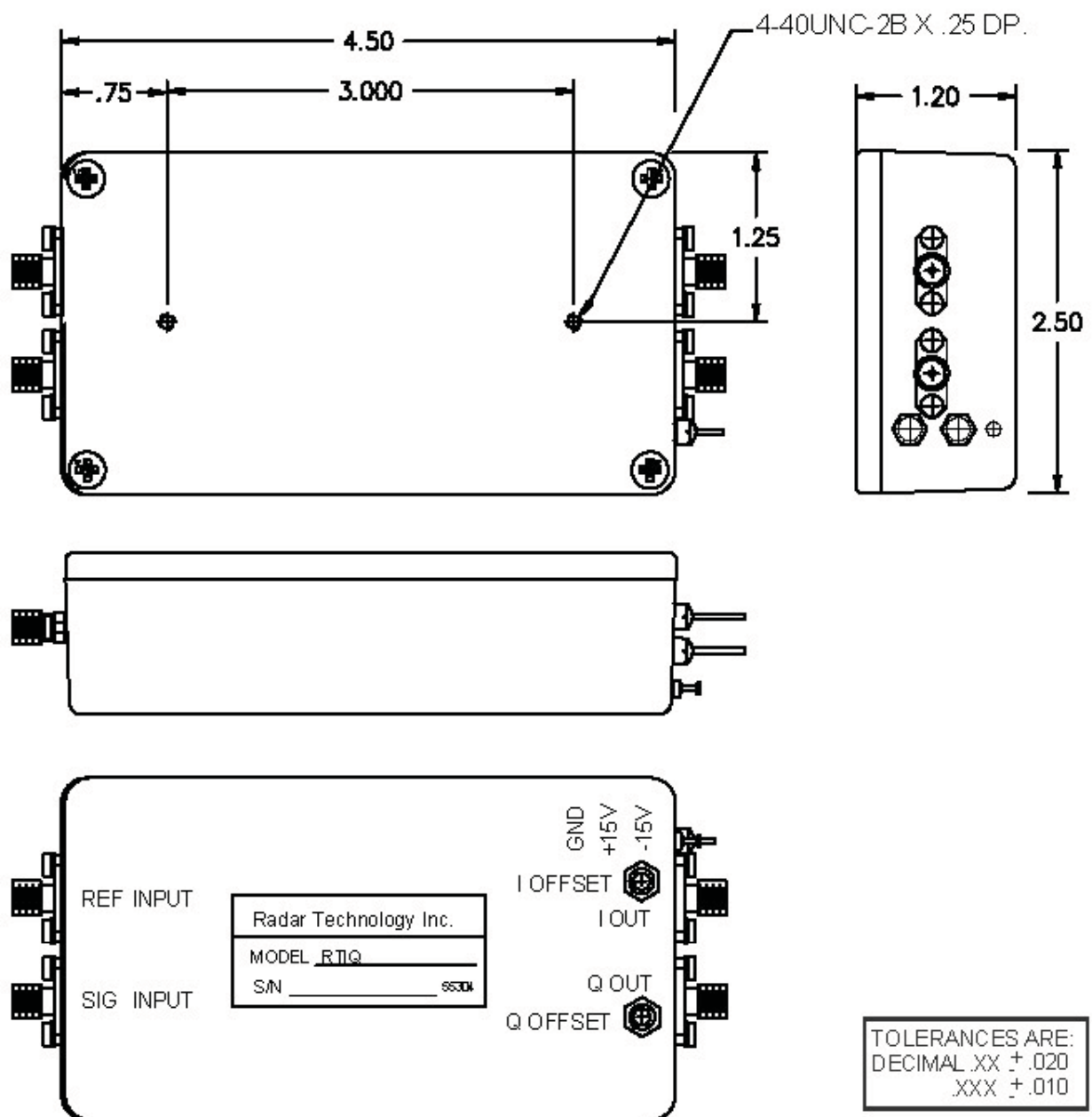

Notes:

1. Chassis material is AL alloy per QQ-A-250 with yellow iridite finish per MIL-C-5541.
2. Top cover is AL alloy, finish semigloss black enamel with white markings approximately as shown.

Monopulse Receiver

The RTM Series of Monopulse IF Processors can be supplied for either amplitude or phase sensing antenna systems. These subsystems employ the $\Sigma + j D$ technique to convert the I.F input signals to a video output with a transfer characteristic: $e_o = K \cos ((\tan^{-1} \Delta/\Sigma) - 90^\circ)$.



General Specifications

Output Voltage	±2.5VDC (nom.)
Source Impedance	50 Ohms
Video Load Impedance	93 Ohms
Power Requirements	± 15VDC
Connectors	SMA

Key Features

- Rugged Design
- Small Footprint 8.0 x 4.75 x 0.75
- Optional Log Video Output

Optional Specifications

Power Supplies	±12V DC (add suffix C)
Boresight Null	40dB (min) (may affect angular accuracy)

Design Note: Radar Technology can customize any of our products to meet your individual system requirements. RTI also offers many form, fit, function replacements to old RHG Electronics Amplifiers.

Specification Table

Model	Center Frequency (MHz)	Bandwidth (MHz)	Rise Time (ns)	Input Signal Level Range (dBm)	Angular Accuracy (Deg.)
RTM-3010	30	10	70	-60 to 0	±5
RTM-6020	60	20	70	-60 to 0	±5
RTM-7020	70	20	70	-60 to 0	±5
RTM-16020	160	20	70	-50 to 0	±5
RTM-35020	350	20	70	-50 to 0	±5

*Parameters can be modified to meet specific application requirements

Outline Drawing

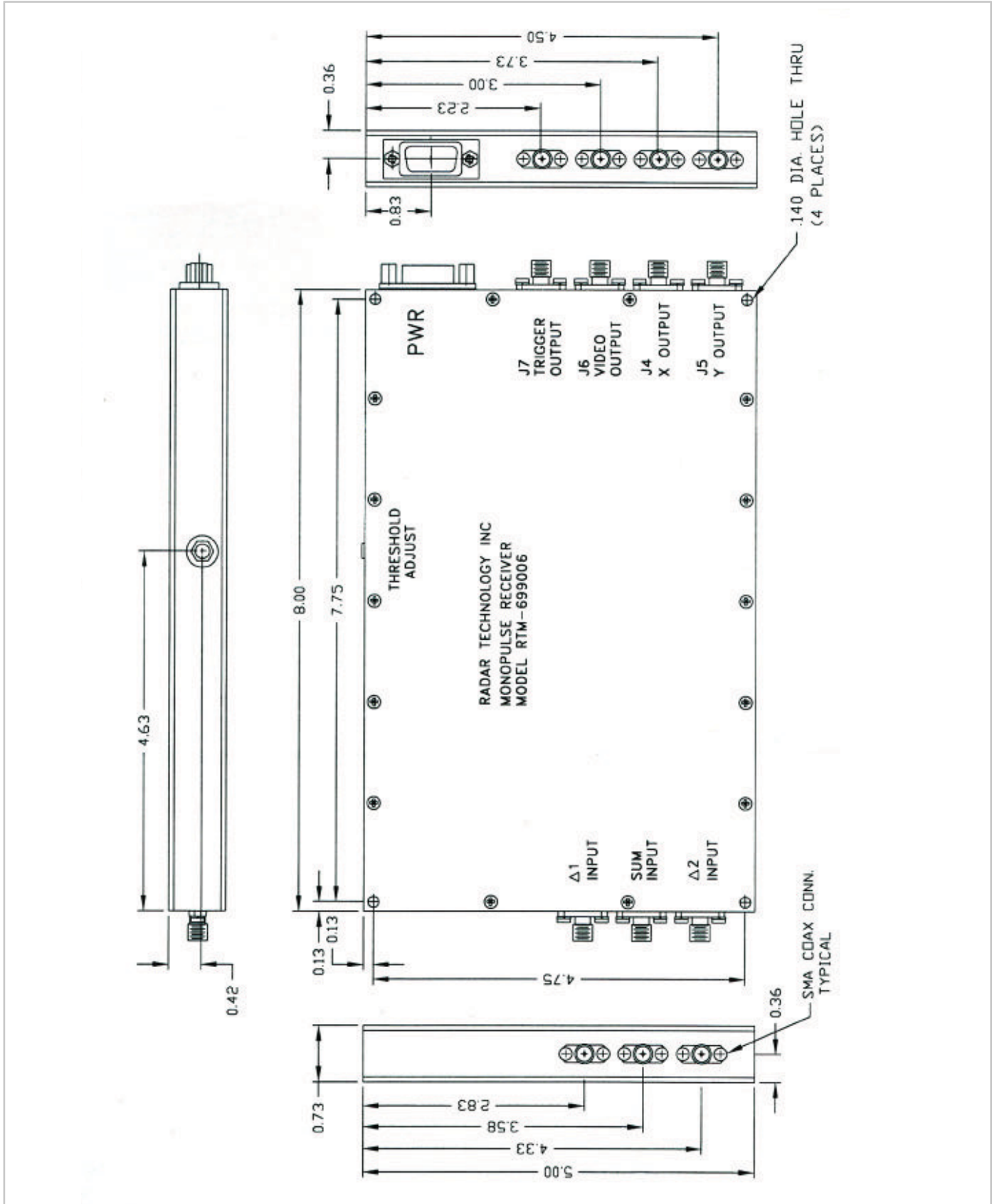

Doppler Radar Receiver

The RTR series of Doppler Radar Receiver was developed by RTI to measure the Doppler phase shift (I/Q Outputs) and intensity (Log output) in Radar applications.

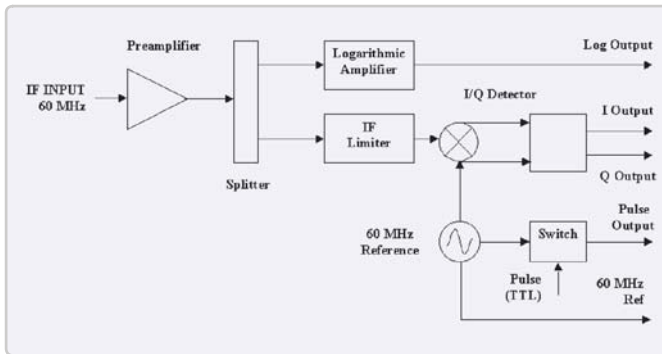

Design Note: Radar Technology can customize any of our products to meet your individual system requirements. RTI also offers many form, fit, function replacements to old RHG Electronics Amplifiers.

IF INPUT	
Frequency	30 or 60 MHz
Input Signal Level	-110 to -30 dBm
Input VSWR	< 2:1
Bandwidths (other bandwidths up to 3MHz available at time of order)	0.15 / 0.38 / 1.2 MHz (user selectable)

LOGARITHMIC AMPLIFIER OUTPUT	
Load Resistance	50 W
Slope	25±1 mV/dB
Output Voltage: (user defined at time of order)	1V±0.1V(IF input = -30 dBm) -1V±0.1V(IF input = -110 dBm; Bandwidth = 0.15 MHz)
Rise Time:	< 6mS (Bandwidth = 0.15 MHz) < 3mS (Bandwidth = 0.38 MHz) < 700 nS (Bandwidth = 1.2 MHz)
Fall Time:	<16 mS (Bandwidth = 0.15 MHz) < 8mS (Bandwidth = 0.38 MHz) < 2 mS (Bandwidth = 1.2 MHz)

I/Q OUTPUT	
Load Resistance	50 W
Maximum Voltage Swing (user defined at time of order)	+ -1 V
Amplitude Balance	± 0.5 dB max
Phase Balance	± 5 ° max

*Parameters can be modified to meet specific application requirements

PULSE OUTPUT	
Frequency	30 or 60 MHz
Load Resistance	50 W
Output VSWR	< 2:1
Output level ("on" state)	5 ±1 dBm
Output level ("off" state)	< -95 dBm
Video (TTL) leakage	30 mV pp typ.
Rise/Fall Time	< 20 nS
Switching Time (turn on/off)	< 30 nS

REFERENCE OUTPUT	
Frequency	30 or 60 MHz
Load Resistance	50 W
Output VSWR	< 2
Output level	5 ±1 dBm
Frequency Stability (over temperature range -30 to +71°C)	±2.5 ppm max
Phase Noise (20 KHz offset)	< -130 dBc/Hz

POWER SUPPLY CURRENT	
+15 V	<250 mA
-15 V	<400 mA